



Authors

Graham Broadway

Andrew Tipler

PerkinElmer, Inc.
Shelton, CT USA

Ozone Precursor Analysis Using a Thermal Desorption-GC System

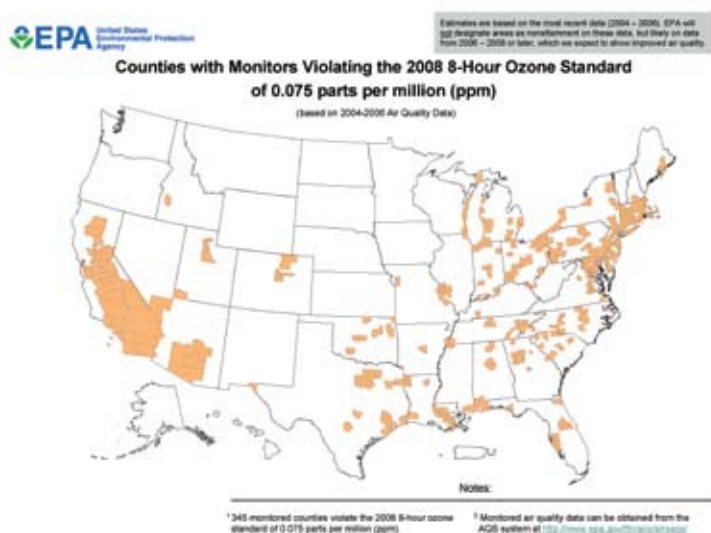

Figure 1. Areas expected to violate the 2008 Ozone Standard.

In the United States, the Clean Air Act of 1970 gave the U.S. Environmental Protection Agency (EPA) responsibility for maintaining clean air for health and welfare. Six parameters are measured routinely in ambient air: SO_x , NO_x , PM_{10} (particulate matter less than 10 microns), Pb, CO and ozone. In the 1990 Clean Air Act Amendments, Title 1 expanded the measurements in air to include volatile organic compounds (VOCs) that contribute to the formation of ground-level ozone. These parameters are measured in urban areas that do not meet the attainment goals for ozone, as shown in Figure 1. These measurements are implemented through a program known as Photochemical Assessment Monitoring Stations (PAMS).

This program has been in place in the U.S. for a number of years, and in 2008 the National Ambient Air Quality Standards (NAAQS) for Ground-Level Ozone was reduced to 0.075 ppm for an 8-hour period.¹ The U.S. EPA predicts that a large number of counties will violate the 2008 standard² (Figure 1). Similar recommendations have also been made in Europe. Following the 1992 Ozone Directive and United Nations Economic Commission for Europe's protocol on controlling VOC emissions, a European ozone precursor priority list was established by Kotzias et al.³ and subsequently modified by the EC 2002/3/CE directive.

The analysis of C₂ to C₁₂ volatile organic ozone-precursor compounds can present a serious technical challenge to the analytical chemist. Low concentrations in the atmosphere coupled with the need to monitor frequently to assess diurnal variations means that a preconcentration step on the sample before analysis by gas chromatography (GC) is required. While the samples can be collected in the field and returned to the laboratory, on-line analysis in the field allows reduced data turnaround time, minimizes sample-collection hardware and permits the presence or absence of VOCs to be correlated with meteorological data. In the field, low-molecular-weight C₂ VOCs can be trapped on solid adsorbents if those adsorbents are cryogenically cooled. However, this presents a serious cryogen-use problem. It is difficult to get liquid nitrogen routinely delivered to remote locations and its use can make these analyses costly and dangerous. This white paper describes a method, developed by PerkinElmer in conjunction with the U.S. EPA, to collect and measure C₂ to C₁₂ automatically in the field, without the use of liquid cryogen.⁴ This system has been updated to support the use of thermal desorption (TD) systems, the PerkinElmer® TurboMatrix™ Thermal Desorbers.

System Requirements

Table 1 lists the 54 (meta and para xylenes are counted as one compound) ozone-precursor target analytes specified in the U.S. EPA “Technical Assistance Document for Sampling and Analysis of Ozone Precursors”, EPA/600-R-98/161, September 1998, issued by National Exposure Research Laboratory, Research Triangle Park, NC 27711, USA. This document is available from the U.S. EPA web site at: <http://www.epa.gov/ttn/amtic/files/ambient/pams/newtad.pdf>. These target compounds vary tremendously in their volatilities and therefore place special demands on their collection and subsequent gas chromatography. Furthermore, the method requires that each sample must be collected over a period of time not less than 40 minutes in each hour and be analyzed at hourly intervals. For unsupervised operation, this means that each analysis must take less than one hour in total.

The European Union measures a smaller number of compounds. These are listed in Table 2. Although the European Union list is smaller than the U.S. EPA list, it also includes the requirement to measure 1,3-butadiene which is not in the U.S. list of analytes.

Table 1. U.S. EPA Ozone Precursor Target Analytes.

ethylene	2,3-dimethylbutane	n-octane
acetylene	2-methylpentane	ethylbenzene
ethane	3-methylpentane	m & p-xylene
propylene	n-hexane	styrene
propane	methylcyclopentane	o-xylene
iso-butane	2,4-dimethylpentane	n-nonane
1-butene	benzene	isopropylbenzene
n-butane	cyclohexane	n-propylbenzene
trans-2-butene	2-methylhexane	m-ethyltoluene
cis-2-butene	2,3-dimethylpentane	p-ethyltoluene
iso-pentane	3-methylhexane	1,3,5-trimethylbenzene
1-pentene	2,2,4-trimethylpentane	o-ethyltoluene
n-pentane	n-heptane	1,2,4-trimethylbenzene
isoprene	methylcyclohexane	n-decane
trans-2-pentene	2,3,4-trimethylpentane	1,2,3-trimethylbenzene
cis-2-pentene	toluene	m-diethylbenzene
2,2-dimethylbutane	2-methylheptane	p-diethylbenzene
cyclopentane	3-methylheptane	n-undecane

Table 2. European Union Ozone Precursor Analytes.

ethylene	iso-pentane	n-heptane
acetylene	1-pentene	toluene
ethane	n-pentane	n-octane
propylene	isoprene	ethyl benzene
propane	cis-2-pentene	m & p-xylene
iso-butane	trans-2-pentene	o-xylene
1-butene	2-methylpentane	1,3,5-trimethylbenzene
n-butane	n-hexane	1,2,4-trimethylbenzene
trans-2-butene	benzene	1,2,3-trimethylbenzene
cis-2-butene	2,2,4-trimethylpentane	1,3-butadiene

System Overview

Figure 2 gives a schematic diagram of the key components that comprise the PerkinElmer Online Ozone Precursor Analyzer. A TurboMatrix TD with installed online sampling accessory is responsible for collecting the sample, either directly from ambient air or from a sample previously stored in a passivated canister. The TD extracts the analytes from the sample onto a cooled adsorbent trap. The trapped analytes are thermally desorbed and carried through a heated transfer line by carrier gas into the Clarus® 500 Gas Chromatograph (GC). The TurboMatrix TD may be selected from a range of five models, depending on the user’s requirements. The TurboMatrix 100 and 300 are single-sample-tube analyzers, the 100 having manual pneumatic control while the 300 has programmable pneumatic control

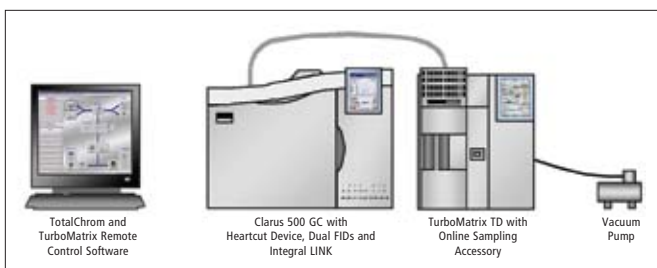

Figure 2. Key components of the PerkinElmer Online Ozone Precursor Analyzer.

(PPC) that enables all gas-flow rates to be programmed and controlled through the software. The models 150, 350 and 650 take up to 50 sample tubes, the 150 pneumatics are controlled manually while the 350 and 650 have PPC. The 650 also incorporates a “dry-purge” facility which would be extremely useful for the analysis of samples collected for analysis using U.S. EPA methods TO-14, TO-15 and TO-17.

The Clarus GC contains two columns and a heartcut device to separate, by volatility, the analytes into two fractions. The more-volatile fraction is separated on a PLOT (Porous Layer Open Tubular) column whereas the less-volatile fraction is separated on a dimethyl siloxane column. A flame ionization detector (FID) monitors the chromatography on each column. The PC runs the TotalChrom® data-handling system and the TurboMatrix remote control software to provide the automated control and review of the settings and conditions that control the GC, the TD and the data processing. As an option, third-party remote control software may be used to provide access to the PC and the applications running on it from a remote location.

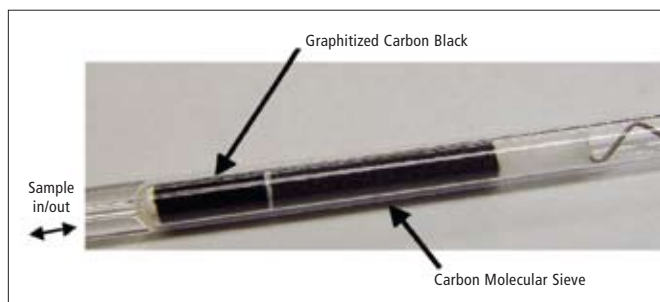

Figure 3. Photograph of the PerkinElmer Air Toxics Trap.

Key Features of System

- Fully complies with U.S. EPA “Technical Assistance Document for Sampling and Analysis of Ozone Precursors”, EPA/600-R-98/161
- Unattended operation
- Simultaneous chromatography on two columns
- Unique heartcut device enables parallel chromatography for increased throughput and chromatographic resolution
- Hourly sampling
- Simultaneous sampling and chromatography
- Automatic system calibration
- Full data processing
- Optional total-system remote control of the thermal desorber, the gas chromatograph and the data processing via telephone, internet or local area network
- Cryogen-free operation
- Sample information inserted into result files
- Complete analytical package supplied and supported by a single vendor

Sample Collection

Modern adsorbents, when used in combination, are effective in retaining all the target analytes at the minimum TurboMatrix TD Peltier-cooled trap temperature of -30 °C. This totally eliminates the need for liquid cryogen. Figure 3 shows a photograph of the PerkinElmer Air Toxics Trap used on this system to collect the air sample. This same trap is also used in the PerkinElmer Air Toxics System for analyses of toxic volatile organic compounds in ambient air, according to U.S. EPA Methods TO-14, TO-15 and TO-17. Figure 4 shows a diagram of the trap’s internal geometry. The sample is drawn into the cooled trap from the left-hand side in the schematic. When the trap is heated, the desorbed vapors

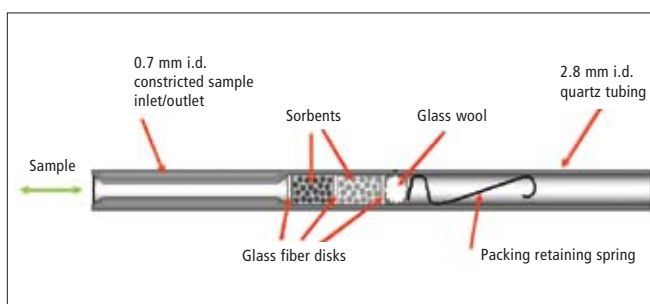

Figure 4. Internal geometry of the PerkinElmer Air Toxics Trap.

exit again from the left-hand side. This section of the trap is reduced in diameter (0.7 mm) to minimize vapor dilution, which would result in chromatographic peak broadening and degradation in detection limits. The fast trap heat-up rate (2400 °C/min) also serves to minimize peak broadening. Good peak shapes are produced from this trap during thermal desorption at carrier-gas flow rates within the range of 3 to 5 mL/min. These low flow rates mean that split ratios may be kept to a minimum (1:1 is typical) as the vapors are transferred to the GC column. This trap uses two adsorbents; the weaker (carbon black) adsorbent is towards the sample inlet/outlet and will retain the less volatile analytes from the sample. The stronger (carbon molecular sieve) adsorbent is positioned behind the weaker adsorbent to catch the most volatile analytes (C₂ to C₄). When the trap is heated, the desorbed analytes are backflushed from the trap – this ensures that the less volatile compounds never make contact with the stronger adsorbent. Using just a single adsorbent would require that the trap is operated over a much greater temperature range, and thus this dual adsorbent arrangement facilitates the retention and desorption of all the ozone precursor target analytes, without recourse to liquid cryogen. The retention of C₂ compounds on this trap is shown in Figure 5. This demonstrates that acetylene is quantitatively retained from 600 mL of air. The retention volumes for other C₂ hydrocarbons exceed 1.2 L at -30 °C and over 4 L for C₃ hydrocarbons. The use of glass-fiber filter disks keeps the packing beds apart without introducing dead volumes into the flow path. The adsorbent is retained by the reduced-trap inner walls at one end and by a spring at the other end, so the adsorbents are kept in their optimum position during operation.

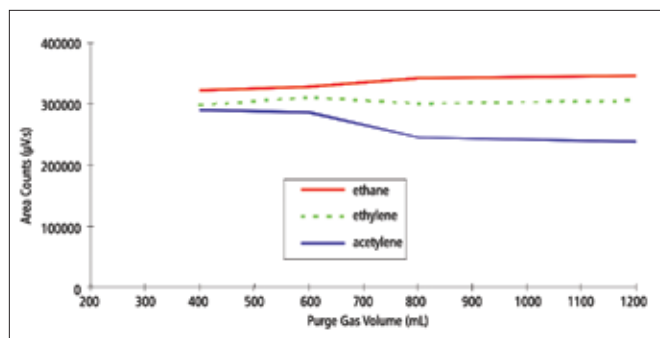

Figure 5. C₂ hydrocarbons recovery vs. sample gas volume (16-19 ng per compound).

The Thermal Desorption System

Figures 6 to 8 show schematic diagrams of the thermal desorption system used for this application. These figures represent only a few of the stages necessary to perform this analysis, but they illustrate how the system collects and then desorbs the sample analytes to the GC. The core TD technology is to the left and the online sampling accessory is to the right of the dotted line in Figures 6 to 8.

A rotary valve (*RVC*) selects whether a sample or a calibration standard mixture is to be run. The position of this valve is controlled from the TotalChrom data-handling sequence so that scheduled automatic recalibration of the system is possible. Once the sample (or standard) passes through *RVC*, it is fed through a Nafion® membrane dryer to remove moisture. Nafion® is a perfluorosulfonic acid polymer that is permeable to water molecules and is very effective in this application. The membrane will also remove many polar compounds, particularly aliphatic alcohols, ketones, ethers and esters. However, as none of these are on the target list of analytes, this is a direct benefit to this application, since possible interferences will be removed from the sample. A flow of dry air is supplied via an electrical solenoid valve (*ISV2*) to remove the extracted water and to keep the membrane operating under optimum conditions.

When the system is idle, the sample stream is directed through another rotary valve (*RVB*) to an electronic flow controller and a vacuum pump (Figure 6). This arrangement allows the system to sample air at ambient pressures or even (in the case of canister samples) at pressures below ambient at a user-settable sampling rate. An electrical solenoid valve (*ISV1*) will close in the event of a power interruption so that the loss of an expensive standard gas mixture does not occur under these circumstances.

To take a sample, *RVB* is rotated as shown in Figure 7 (Page 5). This directs the sample stream through an empty tube (used just as a conduit), through *RVA* and into the cooled trap where the analytes are retained. The outlet of the trap is taken back through *RVB* and out to the electronic flow controller and vacuum pump. The sample will be collected at the set flow rate for a set period of time – both are settable by the user through the TurboMatrix touchscreen.

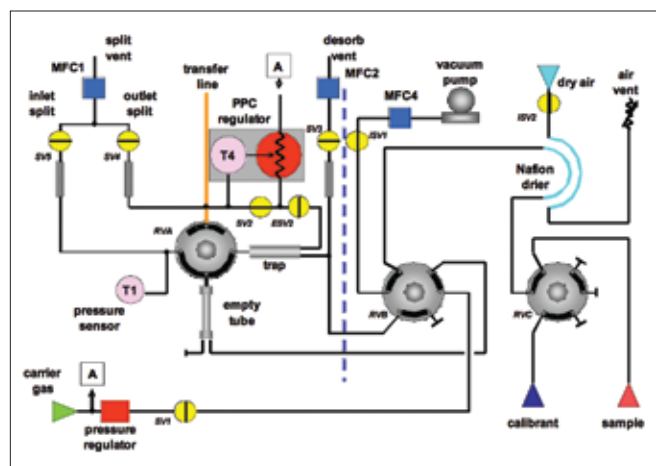

Figure 6. The PerkinElmer TurboMatrix TD system with fitted online sampling accessory – idle position (figure shows the pneumatics for the TurboMatrix 300 and 350).

Gas Chromatography

Once the desorbed sample vapor is delivered to the GC, the 55 target compounds given in Table 1 must be separated, identified and quantified within about 50 minutes in order for the GC to be cooled and ready to start the next analysis an hour later. It would be very difficult to achieve a satisfactory separation of all 55 compounds on a single GC column without recourse to subambient oven temperatures. This would clearly defeat the benefit of eliminating the liquid cryogen from the thermal desorption system.

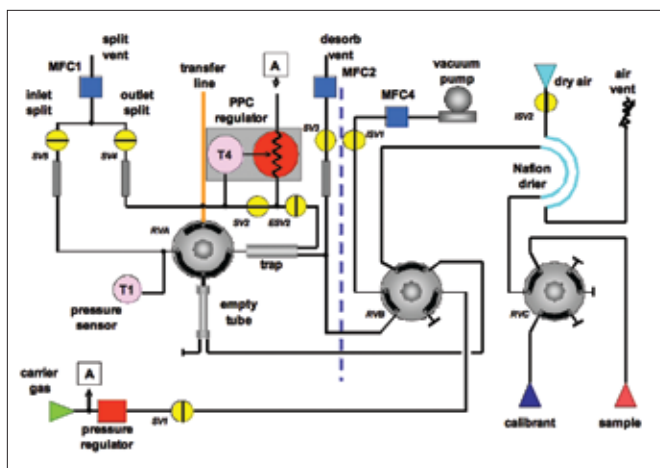

Figure 7. The PerkinElmer TurboMatrix TD system with fitted online sampling accessory – sampling position.

Note that while sample is being collected, carrier gas continues to flow to the GC column from the carrier-gas source A via SV2 so chromatography of the current sample may occur simultaneously with the collection of the next sample. Once the first 40-minute sample has been collected and injected into the GC, the trap automatically cools to $-30\text{ }^{\circ}\text{C}$ and is ready for the next sample after approximately 15 minutes. The next sample begins collection after 20 minutes, while the GC analysis of the first sample is still taking place, ensuring that a sample is collected every hour.

Once the sample has been collected onto the trap, RVB returns to its previous position and RVA rotates and SV2 and ESV2 switch to direct carrier gas through the trap and into the GC column (Figure 8). The trap is heated at this point and desorbed analytes are backflushed into the GC column and chromatography of the analytes is initiated. A small split is applied at the trap outlet by opening SV4 – this sharpens the early-eluting peaks. Figures 6 to 8 show the pneumatic arrangement for the PPC-controlled TurboMatrix systems. One benefit of PPC control is that the pressure sensor (T4) is effectively monitoring the carrier-gas pressure at the head of the column and by feeding this pressure back to the regulator, maintains a constant pressure at the head of the column independently of the cold trap being in-line or off-line and independently of the trap temperature. This ensures that retention times are very repeatable.

The GC will now separate the compounds in the current sample and initiate the collection of the next sample early in the run.

Figure 9 shows a photograph of the thermal desorption instrument with fitted online sampling accessory. Figure 10 shows the same system from the rear with the covers removed to display the key components of the sampling system.

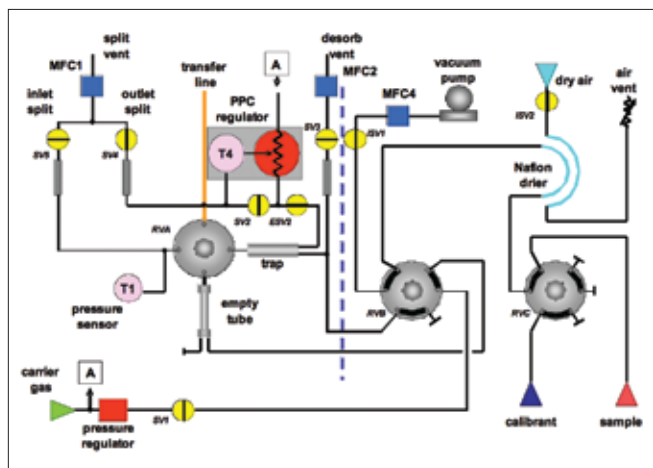

Figure 8. The PerkinElmer TurboMatrix TD system with fitted online sampling accessory – desorb position.



Figure 9. PerkinElmer TurboMatrix 100 TD system with online sampling accessory fitted on rear of instrument.

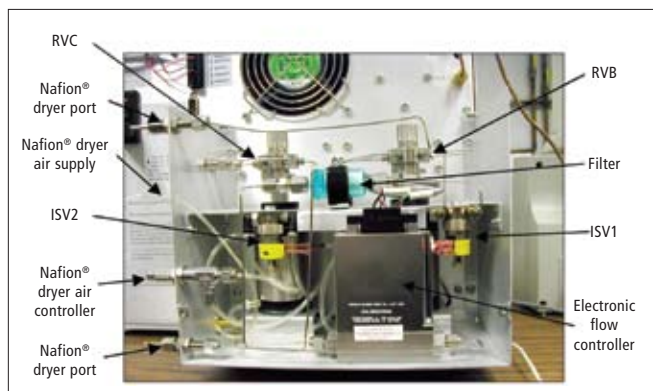

Figure 10. Cover removed from online sampling accessory showing key components.

To separate the very volatile compounds (such as ethane, ethylene and acetylene), a very retentive column such as an alumina PLOT would be required. Although this type of column is ideal for the separation of the light compounds, it has a temperature limit of about 200 °C and would be unable to elute compounds much heavier than hexane.

This limitation is overcome by the addition of a dimethyl siloxane column which is coupled to the PLOT column with a heartcut switch as shown in Figure 11. The heartcut technology used here is based on the Dean's⁸ principle of pressure-balanced switching and has the advantages of being simple, highly inert, low thermal mass and low internal dead-volume.

There are two pressure regulators employed. The first (P1) is on the TD and controls the pressure at the inlet of the dimethyl siloxane column. The second regulator (P2) is attached to the heartcut device in between the two columns. For correct operation, $P1 > P2 > \text{ambient pressure}$. The difference in pressures between P1 and P2 represents the pressure drop across the dimethyl siloxane column and will control the flow rate of carrier gas through it. The pressure P2 represents the pressure across the PLOT column and hence the flow rate of carrier gas through that column. This arrangement allows simultaneous chromatography in both columns.

The heartcut device is used to separate the analytes into two fractions – the more-volatile fraction elutes from the dimethyl siloxane column and is directed into the PLOT column for further chromatography and detection on FID2. The heartcut device is now switched to its other position and the later-eluting compounds from the dimethyl siloxane column are directed to FID1.

Figures 12 and 13 illustrate how this heartcut device works. By the simple switching of a solenoid valve mounted outside the GC oven, the effluent from the column is switched between the two outlets, D and E. The other port continues to be fed with pure carrier gas.

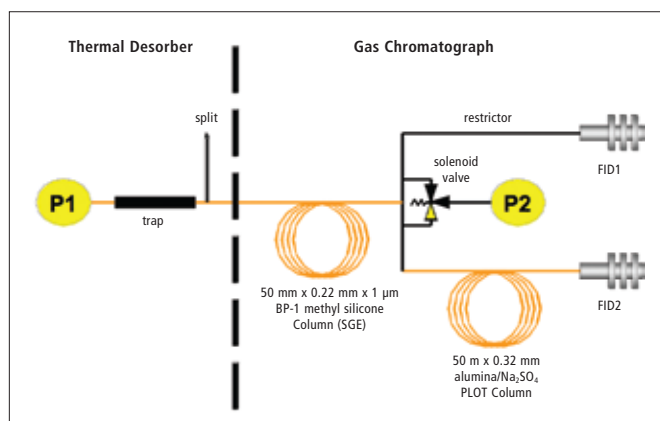

Figure 11. Schematic diagram of GC system showing dual columns configured with a heartcut device.

the pressure at point D must be very close to the pressure at point E. This is achieved by making the pneumatic impedance of the fused-silica restrictor tubing in Figure 11 close to that of the PLOT column – hence the term “pressure-balanced switching”.

A needle valve is connected across the switching ports on the heartcut device. This maintains a trickle flow of carrier gas through the otherwise unswept plumbing lines to ensure that no sample material is lost or is re-injected as the analysis proceeds.

Figure 14 (Page 7) shows the separation of a 10-ppb standard of 55 PAMS compounds through the dimethyl siloxane column (i.e., no heartcut). The separation before n-hexane is not good enough but is acceptable for later-eluting compounds. The heartcut device is used, therefore, to direct those compounds eluting before n-hexane on to the PLOT column. To set up the heartcut time, the chromatogram is expanded on the TotalChrom screen to display the portion shown inside the dotted line. This is shown in Figure 15 (Page 7). The cut time is then set just before the n-hexane peak which is the first of a group of three peaks and just has baseline separation from the peak eluting after it. Figure 16 (Page 7) shows the next analysis where the early-eluting compounds from the dimethyl siloxane column have been directed to the PLOT column. Note that no shift in retention time of the peaks eluting after the cut time is observed. This is because the “pressure-balanced” switch maintains the same pressure drop across the dimethyl siloxane column independent of which direction the early compounds are directed. Chromatography of both of the

more-volatile and less-volatile fractions will proceed in parallel as shown in Figure 17 (Page 7). This approach eliminates the need for subambient chromatography and will produce two chromatograms for each analysis.

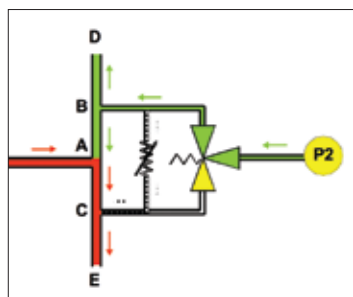

Figure 12. Heartcut device, switching column effluent from point A to PLOT column at point E.

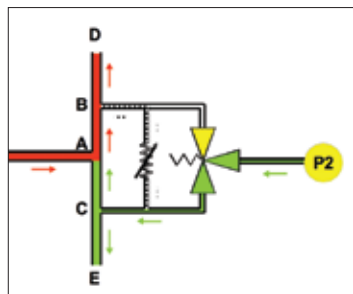

Figure 13. Heartcut device, switching column effluent from point A to FID1 at point D.

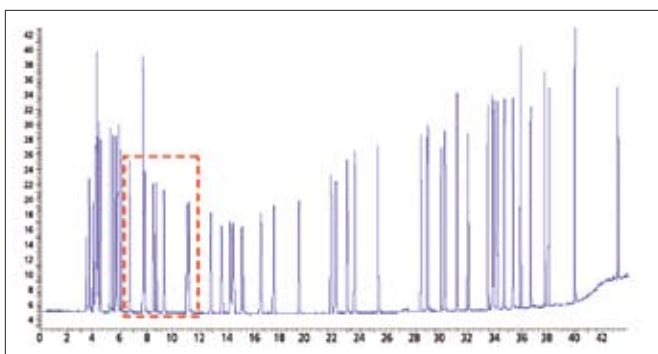

Figure 14. 10-ppb standard mixture chromatographed with effluent from methyl silicone column directed to FID1.

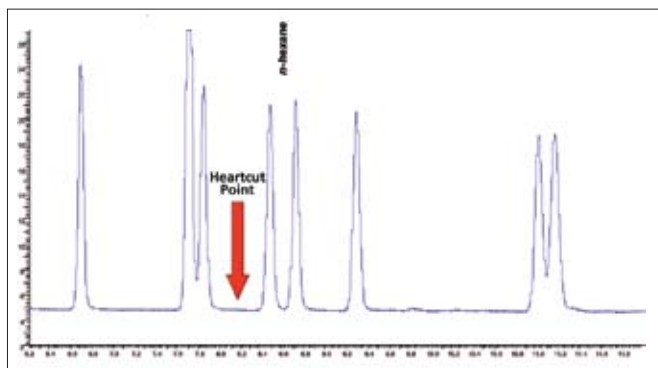

Figure 15. Establishing the cut time.

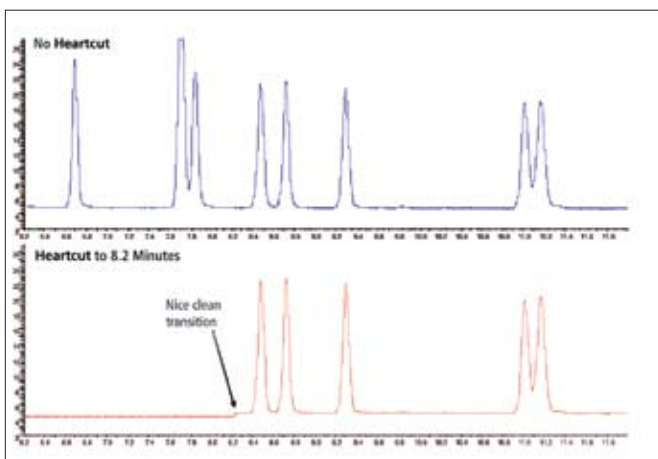

Figure 16. Chromatograms showing the heartcut point.

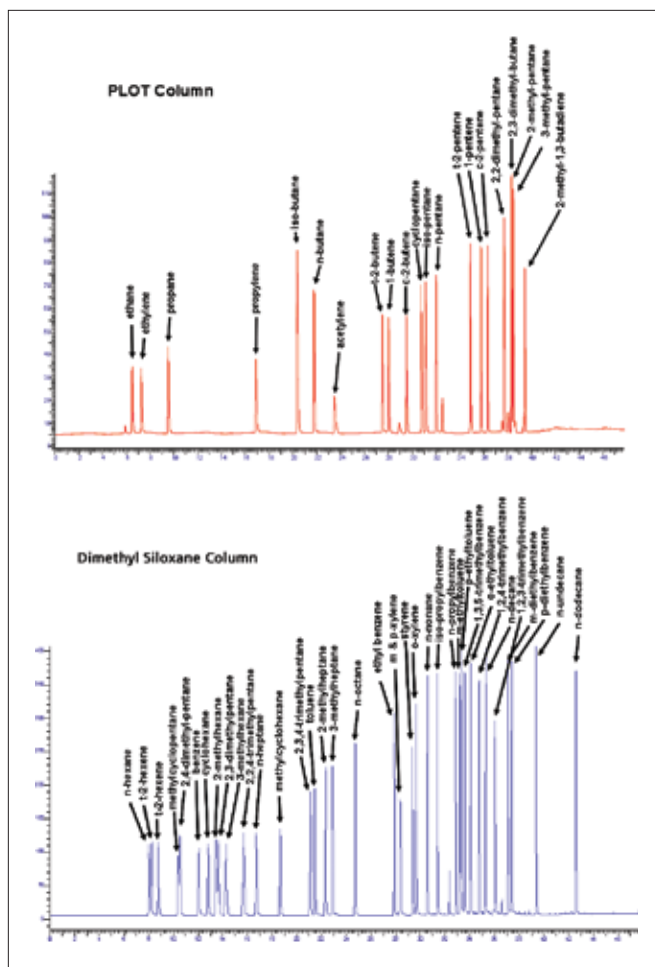

Figure 17. Parallel chromatography of the two sample fractions on the dimethyl siloxane and PLOT columns.

Experimental

The full instrumental conditions for this analysis are given in Table 3.

Table 3. System Conditions for Ozone Precursor Analysis.

Chromatograph	Clarus 500 GC with heartcut device and Integral LINK
Column	Ozone Precursor Column Set: <ul style="list-style-type: none">• 50 m x 0.22 mm x 1 μm dimethyl siloxane column• 50 m x 0.32 mm alumina/Na_2SO_4 PLOT column
Oven	46 °C for 15 minutes, then 5 °C/minute to 170 °C, then 15 °C/minute to 200 °C and hold for 6 minutes (48-minute chromatogram)
Detector	Dual Flame Ionization Detectors at 250 °C
Carrier Gas	48 psig helium at the pre-column inlet 17 psig helium at the heartcut device
Thermal Desorber	TurboMatrix TD with online sampling accessory
Trap	Air Toxics trap packed with carbonaceous adsorbents
Trap Low	-30 °C
Trap High	325 °C
Transfer Line	200 °C
Operating Mode	On Line
Inlet Split	Off
Outlet Split	2 mL/min (~1:1 split ratio)
Data Handling System	TotalChrom and TurboMatrix remote control software
Air Sampling	15 mL/min for 40 min (600 mL total)

Performance

The success of this analysis depends to a large extent on whether a few critical chromatographic separations are achieved.

Figures 18 and 19 give an overview of the critical separations.

Figure 20 (Page 9) shows critical separation 'A', a low concentration of isobutene near several peaks often observed at higher concentration. This compound is thought to be produced as an artifact in the Nafion® Dryer and therefore good detection at a low level is required.

Figure 21 (Page 9) shows critical separation 'B' between iso-pentane and cyclopentane. A good separation is seen between these two very similar compounds.

Figure 22 (Page 9) shows critical separation 'C' between the three compounds, 2,3-dimethylbutane, 2-methylpentane and 3-methylpentane. This standard only contained a trace of 3-methylpentane.

Figure 23 (Page 9) shows critical separation 'D'. n-Hexane is the first peak to elute from the dimethyl siloxane column into FID1 after the heartcut has switched. A minimal baseline disturbance, like the one shown here, is sought.

Figure 24 (Page 9) shows critical separation 'E' highlighting the separation of toluene. Toluene is an important reference peak for this analysis and therefore needs to be well resolved.

The results in Figure 17 (Page 7) show the chromatography on the alumina PLOT and dimethyl siloxane columns, with all the compounds identified. In addition to accurate quantification, the method must be precise and stable for reliable operation in remote areas. Retention time stability is primarily dependent on two parameters: a reproducible column temperature from analysis to analysis and good regulation of the carrier-gas pressure gradient across the column. By using programmable pneumatic control (PPC), the pressure gradient is much more repeatable than with more conventional pneumatics. This is demonstrated by the retention time stability on the methyl siloxane column shown in Table 4 (Page 10).

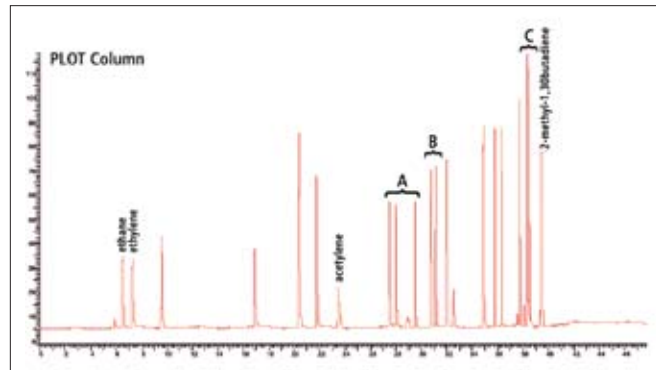

Figure 18. Critical separations on the alumina PLOT column.

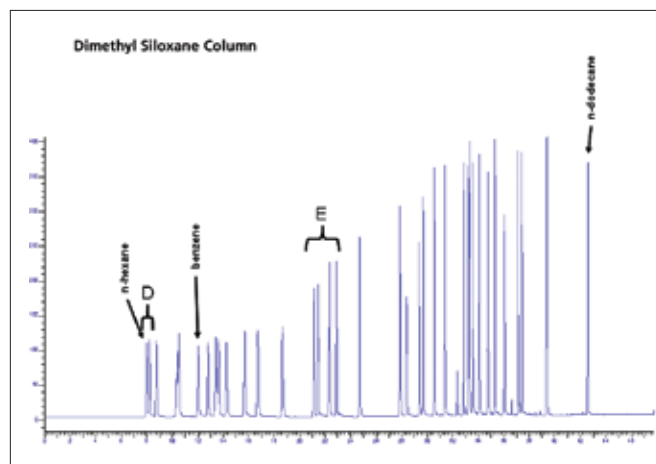

Figure 19. Critical separations on the dimethyl siloxane column.

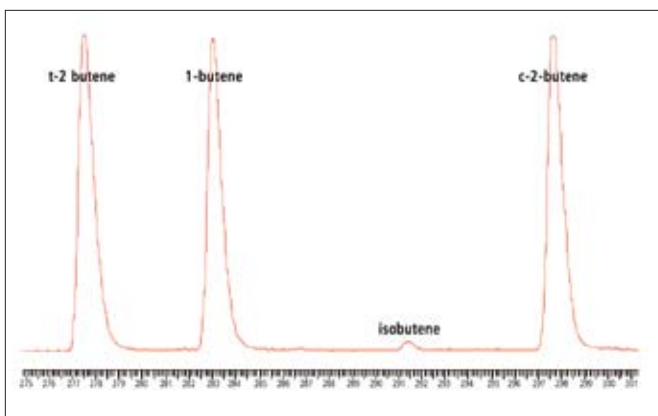

Figure 20. Critical separation 'A' – showing a low concentration of iso-butene.

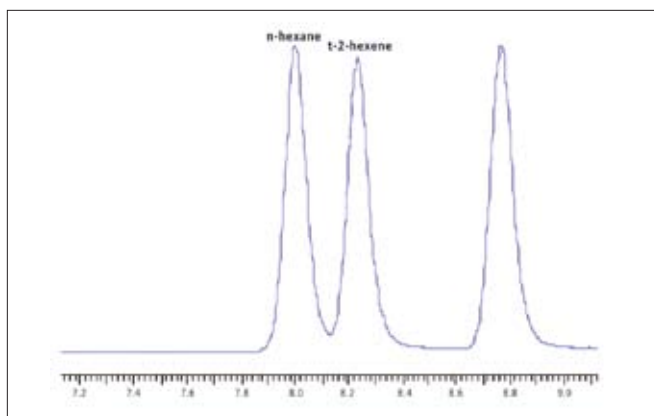

Figure 23. Critical separation 'D' – minimal baseline disturbance.

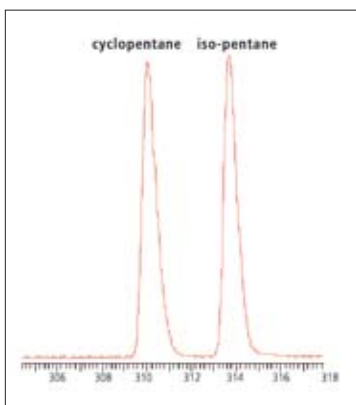

Figure 21. Critical separation 'B' – a good separation between these two compounds is critical.

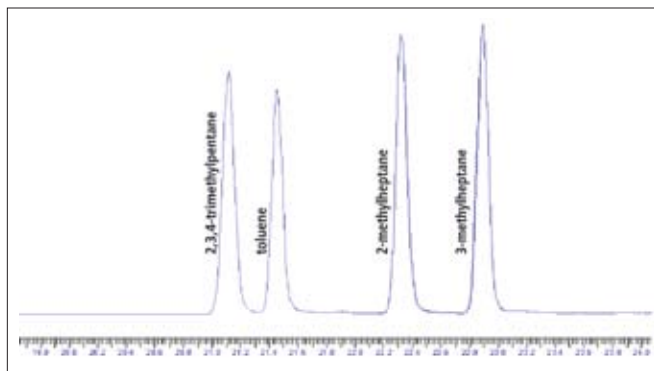

Figure 24. Critical separation 'E' – toluene reference peak well resolved.

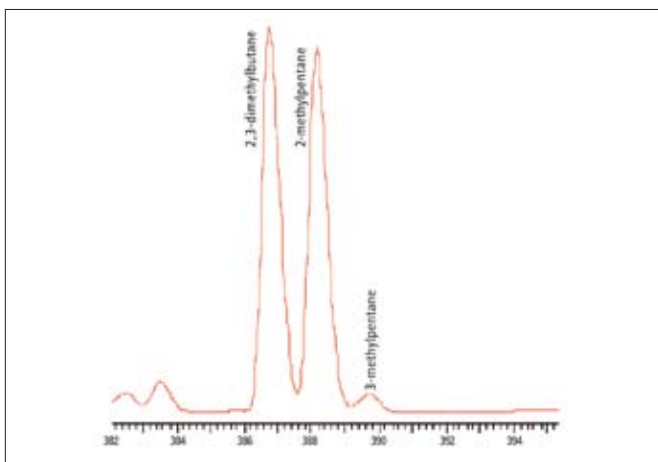

Figure 22. Critical separation 'C' – a good separation is desirable.

Table 4. Retention-Time Stability from Dimethyl Siloxane Column (n=15).

	RSD
n-hexane	0.102%
t-2-hexene	0.110%
c-2-hexene	0.100%
methylcyclopentane	0.107%
2,4-dimethylpentane	0.119%
benzene	0.120%
cyclohexane	0.124%
2-methylhexane	0.127%
2,3-dimethylpentane	0.120%
3-methylhexane	0.134%
2,2,4-trimethylpentane	0.110%
n-heptane	0.093%
methylcyclohexane	0.069%
2,3,4-trimethylpentane	0.056%
toluene	0.051%
2-methylheptane	0.041%
3-methylheptane	0.037%
n-octane	0.031%
ethyl benzene	0.018%
m & p-xylene	0.021%
styrene	0.016%
o-xylene	0.015%
n-nonane	0.013%
iso-propyl benzene	0.014%
n-propylbenzene	0.012%
m-ethyltoluene	0.013%

The compound retention times on the PLOT column, however, are also affected by another parameter: the amount of water vapor present. The amount of water vapor that enters the column is regulated by the Nafion® dryer through which the sample passes before being trapped in the cold trap. The Nafion® dryer is a semi-permeable membrane through which water, and other polar species, will migrate. The outer surface of the membrane is swept with dry air which will remove any water that has permeated the membrane. It is therefore essential that dry air is used. A slightly larger dryer, which also works on the Nafion® principle, may be used to provide dry air for the Nafion® dryer. Figure 24 (Page 9) shows the dew point of a stream of air derived from an environmental chamber set at 35 °C (95 °F) and 85% relative humidity. It can be seen that after an initial start-up time of 2 to 3 hours, the dew point of the air exiting the dryer is stable at around -30 °C to -33 °C. In fact, the dew point of the air at the exit of the dryer is more dependant on the temperature of the dryer than on the initial air supply and will change by approximately one degree Celsius for every degree Celsius rise in the dryer temperature.¹¹

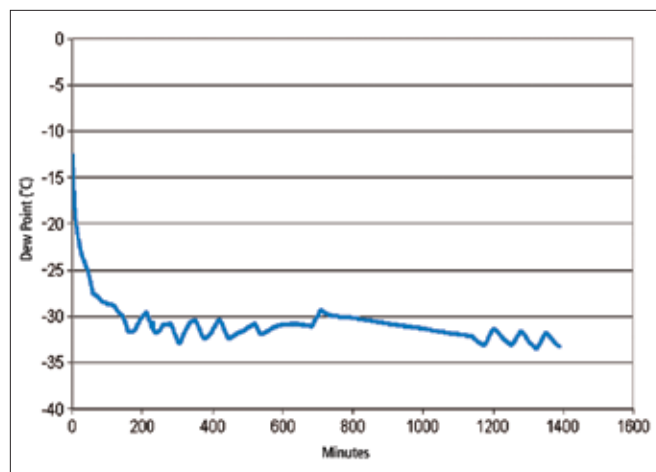

Figure 25. Dew point of air at exit of the air dryer.

By using a Nafion® dryer and by giving the column a short re-conditioning step by programming the column to 200 °C for 6 minutes at the end of each analysis, the retention-time stability on the PLOT column is very good. Table 5 shows the repeatability of the PLOT column.

Table 5. Retention-Time Repeatability from the PLOT Column (n=14).

	RSD
ethane	0.047%
ethylene	0.063%
propane	0.083%
propylene	0.134%
iso-butane	0.090%
n-butane	0.079%
acetylene	0.093%
t-2-butene	0.049%
1-butene	0.051%
c-2-butene	0.044%
cyclopentane	0.046%
iso-pentane	0.049%
n-pentane	0.045%
t-2-pentene	0.034%
1-pentene	0.037%
c-2-pentene	0.036%
2,2-dimethylbutane	0.041%
2,3-dimethylbutane	0.079%
2-methylpentane	0.039%
3-methylpentane	0.041%
2-methyl-1,3-butadiene	0.046%

In Figure 26, a series of analyses were performed by drawing a sample at 15 mL/min of a 100 ppb standard at 75% RH that had been diluted 10:1 with nitrogen. The nitrogen was then replaced by air derived from an environmental chamber at 35 °C and 85% RH. The first samples would have a relative humidity of about 7% RH at 21 °C, equivalent to about 1.3 mg/L of water. The air from the environmental chamber contains about 38 mg/L of water.

Such a large change in moisture content of the air has caused a small shift in retention time of some compounds, more notably the highly unsaturated compounds and those containing a triple bond. This sudden and large change in moisture content is unlikely to occur with real samples and the data-processing method is capable of handling such shifts.

Peak-Area Precision

Table 6 shows the precision obtained from 15 samples of a 100-ppb calibration gas that was diluted 10:1 with nitrogen using mass flow controllers to give the required dilution. The gas samples therefore represented a 10-ppb standard. For most analytes, the RSD is less than 5%, representing an error of less than 0.5 ppb. Only n-dodecane exceeded this value, giving an RSD of 6.5% which may be caused by condensation in the pipework through which the sample passed before reaching the TurboMatrix TD sampler.

Any new system that purports to perform this analysis should have its performance compared against that of existing systems. Figures 26 and 27 show how the recoveries on this new system match up against well-validated and established systems that are run routinely. The EPA data was produced on the original standard mixture used for the other studies and was generated on a system using a single column (with subambient cooling). On this system, the 2-methyl-1-pentene and 2-methyl-2-pentene were not fully separated, which explains why these results for this particular system differed

Table 6. Peak-Area Repeatability (n=15).

	RSD		RSD
ethane	1.64%	2,3 dimethylpentane	1.72%
ethylene	1.94%	3-methylhexane	1.62%
propane	2.08%	2,2,4-trimethylpentane	1.98%
propylene	2.51%	n-heptane	1.96%
iso-butane	1.77%	methylcyclohexane	1.76%
n-butane	2.27%	2,3,4-trimethylpentane	1.84%
acetylene	2.64%	toluene	3.45%
t-2-butene	1.42%	2-methylheptane	2.13%
1-butene	1.66%	3-methylheptane	2.31%
c-2-butene	2.42%	n-octane	2.56%
cyclopentane	1.11%	ethyl benzene	3.74%
iso-pentane	1.32%	m & p-xylene	3.57%
n-pentane	1.47%	styrene	4.01%
t-2-pentene	4.63%	o-xylene	3.69%
1-pentene	1.86%	n-nonane	2.85%
c-2-pentene	2.76%	iso-propylbenzene	3.68%
2,2-dimethylbutane	3.19%	n-propylbenzene	3.72%
2-methylpentane	1.55%	m-ethyltoluene	3.93%
2,3-dimethylbutane	1.54%	p-ethyltoluene	3.93%
2-methyl-1,3-butadiene	2.74%	1,3,5-trimethylbenzene	4.14%
n-hexane	1.61%	o-ethyltoluene	3.73%
t-2-hexene	2.10%	1,2,4-trimethylbenzene	3.98%
c-2-hexene	3.30%	n-decane	3.53%
methyl cyclopentane	1.44%	1,2,3-trimethylbenzene	3.99%
2,4-dimethylpentane	1.50%	m-diethylbenzene	4.72%
benzene	2.42%	p-diethylbenzene	5.13%
cyclohexane	3.40%	n-undecane	2.89%
2-methylhexane	1.85%	n-dodecane	6.53%

from all the others. The other systems are based on the PerkinElmer ATD-400 – the thermal desorption system that preceded the TurboMatrix TD/ATD family. Excellent correlation between the new system and the reference systems is apparent.

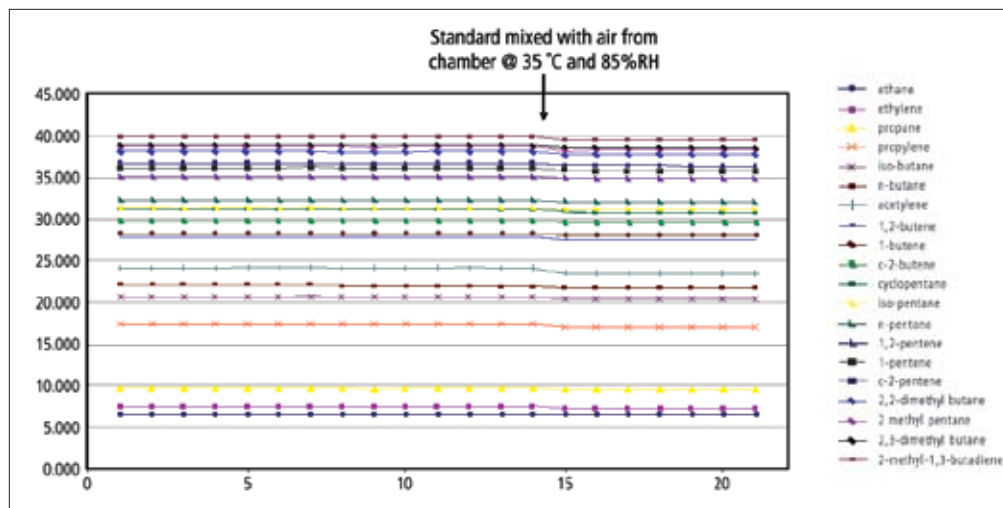

Figure 26. The effect of sampling at 35 °C and 85% relative humidity.

Software Control

The data processing and the GC conditions are fully controlled by the PerkinElmer TotalChrom data-handling system. The TurboMatrix TD is controlled from the same PC using the TurboMatrix remote control software. Between these two software applications, the instrumentation is able to be fully automated for the unsupervised analysis of ozone-precursor target compounds each and every hour. The system is able to automatically run standard mixtures to recalibrate the system according to a predefined sequence. The sample collection and analysis times are logged. Although this is not part of the standard product, third-party software applications such as the Symantec® pcAnywhere™ may be used to remotely access the system via a telephone line, internet or local area network to check on system status, transfer data, adjust conditions, etc.

Some Typical Data from Field Installations

Figure 27 shows the rolling annual mean of benzene and 1,3-butadiene measured at the side of Marylebone Road, a main route through the center of London, U.K. from 1999 to 2001. In 1999, U.K. legislation reduced the level of benzene in unleaded gasoline and the affect of this reduction can be clearly seen in the roadside levels of benzene.¹²

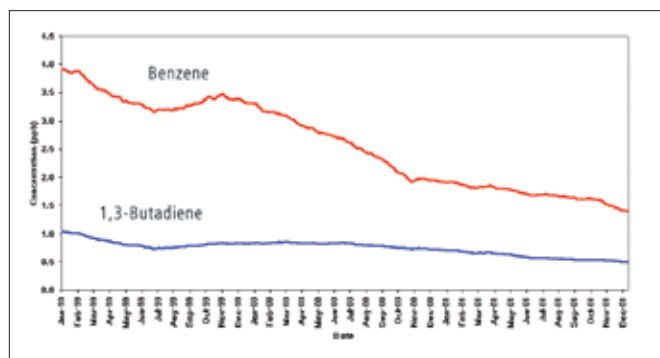

Figure 27. The annual rolling mean of benzene and 1,3-butadiene in London.

Another incident shows a transient of 1,3-butadiene that occurred in a major port in the north of England. A ship delivering 1,3-butadiene to a chemical works flushed its tanks out with nitrogen while in the port. The result was a large vapor cloud which lasted about half a day followed by some smaller spikes as the tanks were flushed two additional times. The ozone precursor monitoring site was directly down wind of the port and recorded the whole episode (Figure 28).¹²

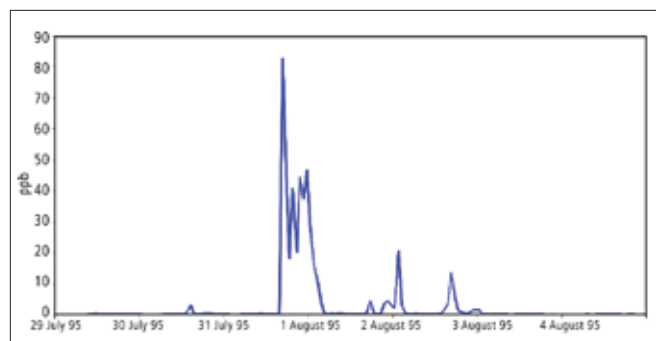

Figure 28. Emission of 1,3-butadiene at a north of England port detected by an Ozone Precursor Monitoring Station.

Conclusions

Air pollution is a global concern. Ground-level ozone has become an increasingly important issue in developed nations, as the health effects of smog are more clearly understood. The monitoring of VOC ozone precursor compounds will continue to play a role in defining and reducing air pollution in developed and developing nations in the next decade. The PerkinElmer On-line Ozone Precursor Analyzer has a proven record of several hundred thousand hours of reliable field operation. With quantitation limits below 0.1 ppb (FID) and the capability of sampling for 40 minutes of every hour, the system meets the requirements of this exacting method. Sophisticated network communications ensure that the Online Ozone Precursor Analyzer provides a robust, 24-hour monitoring solution, ideal for field operation.

The TurboMatrix TD system has been shown to perform U.S. EPA ozone precursor analysis within the specifications required by the method. In addition, the PerkinElmer Online Ozone Precursor Analyzer is smaller, easier to set up and allows total remote control of the system.

References

1. www.epa.gov/air/ozonepollution/standard.html
2. www.epa.gov/air/ozonepollution/pdfs/2008_03_monitors_violating_2008.pdf
3. Kotzias D., Duane M., Munari F. (1995) In: Proceedings of the 3rd international conference on air pollution, Porto Carras, Greece, pp 217–226
4. U.S. EPA “Technical Assistance Document for Sampling and Analysis of Ozone Precursors”, EPA/600-R-98/161, September 1998, issued by National Exposure, Research Laboratory, Research Triangle Park, NC 27711. This document is available from the U.S. EPA web site at: <http://www.epa.gov/ttn/amtic/files/ambient/pams/newtad.pdf>
5. PerkinElmer Thermal Desorption Application Note 29
6. Piell, J.D., Oliver, K.D., McClenny, W.A. JAPCA, 37 (1987) 244-248
7. Broadway, G.M., Trewern, T., Proc. 13th Intl. Symp. on Capillary Chrom., Vol. 1, 310-320
8. Kristensson, J., Schrier, (Ed.), Proc. Analysis of Volatiles, International Workshop, Worzburg, Germany, 28-30 Sept. 1983, 375-378
9. Broadway, G.M., Proc. 9th Australian Symp. on Anal. Chem., Sydney 1987, Vol. 1, 375-378
10. Deans, D.R., Chromatographia 1 (1968) 18
11. Johnson, G.L., Tipler, A., Proc. 8th Intl. Symp. on Capillary Chrom., Vol. 1., 540-549
12. Johnson, G.L., Tipler, A., Crowshaw, D., Proc. 10th Intl. Symp. on Capillary Chrom., Vol. 2, 971-985
13. www.permapure.com/TechNotes/Temperature%20Effects.htm
14. P. Dumitrean, National Environmental Technology Centre, Harwell, Didcot, Oxfordshire, OX11 0QJ, UK

PerkinElmer, Inc.
940 Winter Street
Waltham, MA 02451 USA
P: (800) 762-4000 or
(+1) 203-925-4602
www.perkinelmer.com



For a complete listing of our global offices, visit www.perkinelmer.com/ContactUs

Copyright © 2009, PerkinElmer, Inc. All rights reserved. PerkinElmer® is a registered trademark of PerkinElmer, Inc. All other trademarks are the property of their respective owners.

008880_01